

## The Best Relay



## P1 Relay

ISO  
9001



108-98009  
Rev. C  
EC-JM00-0009-03  
ECOC: JM10  
1. Aug. 04

1 pole telecom and signal relay, polarized,  
Through Hole Type (THT) or  
Surface Mount Technology (SMT),

Relay types:     non-latching with 1 coil  
                      latching with 2 coils  
                      latching with 1 coil

**Features**

- Directly triggerable with TTL standard modules such as ALS, HCT and ACT
- Slim line 13.5 x 7.85 mm, 0.531 x 0.309 inch
- Switching current 1 A
- 1 changeover contact (1 form C / SPDT)
- Bifurcated contacts
- Immersion cleanable
- High sensitivity results in low nominal power consumption  
65 to 130 mW for non-latching  
30 to 150 mW for latching
- Surge voltage resistance between contact and coil:
  - 2.5 kV (2 / 10 µsec) meets the Bellcore Requirement GR-1089
  - 1.5 kV (10 / 160 µsec) meets FCC Part 68

**Typical applications**

- Automotive equipment  
CAN bus, immobilizer
- Office equipment
- Measurement and control equipment
- Medical equipment
- Safety equipment

**Options**

- FCC version on request. Testing of open contacts with surge voltage in accordance with FCC 68.302 (1.5 kV, 10/160 µsec)

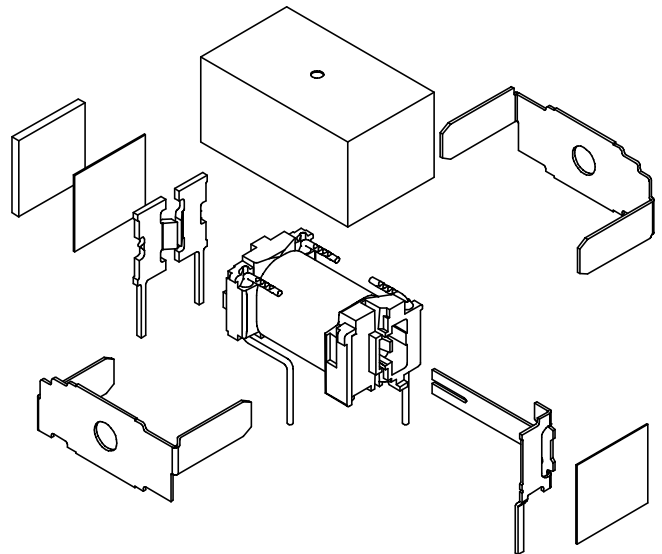
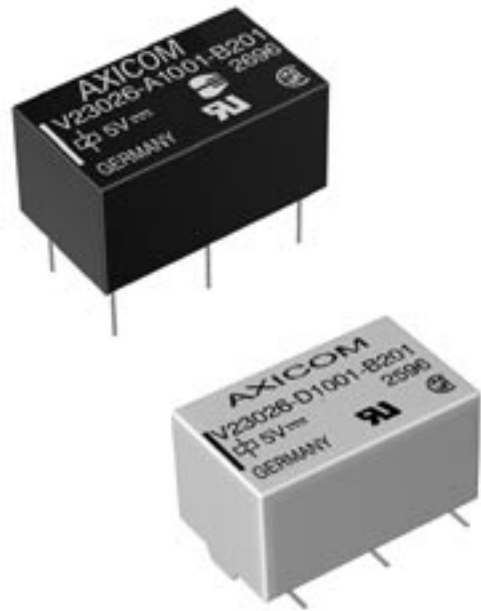

**European Directive conformance:**

P1 relay product conformance according to:

- Directive 2000/53/EC: ELV (End of Life of Vehicles)
- Directive 2002/95/EC: ROHS (Restrictions of the use of certain hazardous substances in electrical and electronic equipment)

Compliance is evidenced by written declaration from all raw material suppliers.

Tyco Electronics AXICOM only has responsibility for the proper processing of these materials.

Confirmation is valid for date codes ≥ 0429



UL File No. E 111441

Basic insulation coil/contacts according to IEC/EN 60950

Clearance > 0.75 mm

Creepage distance > 0.75 mm

Dimensions

V23026-x1xxx-B201				
	THT		SMT	
	mm	inch	mm	inch
L	13.0±0.1	0.512±0.004	13.4±0.1	0.528±0.004
W	7.6±0.1	0.299±0.004	7.75±0.1	0.305±0.004
H	6.9-0.2	0.272-0.008	8.0-0.2	0.315-0.008
T	3.5-0.2	0.138-0.008	N/A	N/A
T1	N/A	N/A	10.9-0.5	0.429-0.020
T2	5.08±0.15	0.200±0.006	5.08±0.15	0.200±0.006
S	0.3±0.1	0.012±0.004	N/A	N/A
S1	N/A	N/A	0.85±0.1	0.033±0.004
S2	N/A	N/A	0.2-0.15	0.008±0.006

THT Version

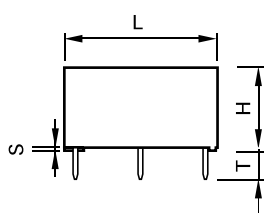

SMT Version

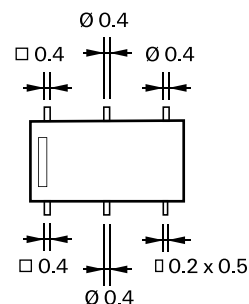
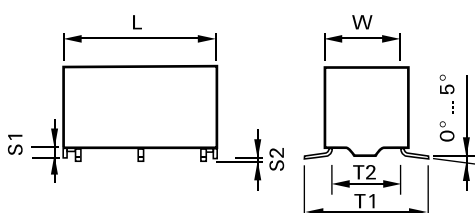

Mounting hole layout

View onto the component side of the PCB

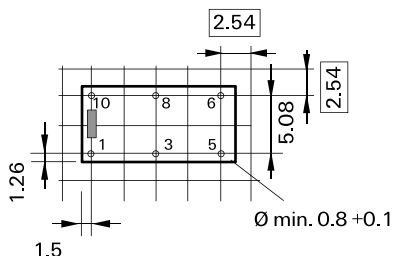

Solder pad layout

View onto the component side of the PCB

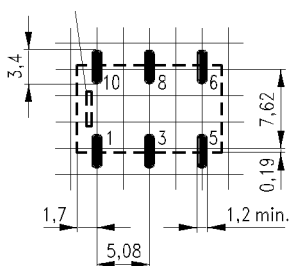

Terminal assignment

Relay - top view

Contact release or reset condition, coil polarity to set the relay

Non-latching type, not energized condition

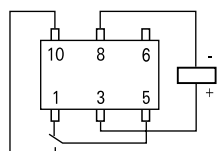

Latching type, 1 coil reset condition

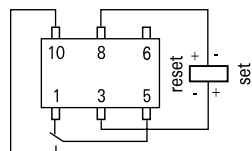

Latching type, 2 coils reset condition

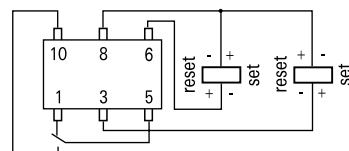

Contacts are shown in reset condition. Both coils can be used either as set or reset coil.

**Coil Data (values at 23 °C)**

**Ordering Information**

Nominal voltage $U_{nom}$	Operate/set voltage range		Release/ reset voltage Minimum	Coil power	Coil Resistance	Relay code	Tyco part number
	Minimum voltage $U_{min}$	Maximum voltage $U_{max}$					
Vdc	Vdc	Vdc	Vdc	mW	$\Omega / \pm 10\%$		

**THT, non-latching, 1 coil**

3	2.25	8.80	0.30	66	137	V23026A1006B201	1-1393774-7
5	3.75	14.50	0.50	68	370	V23026A1001B201	0-1393774-1
9	6.75	25.50	0.90	70	1165	V23026A1005B201	1-1393774-5
12	9.00	35.00	1.20	64	2250	V23026A1002B201	0-1393774-2
24	18.00	50.00	2.40	128	4500	V23026A1004B201	1-1393774-2

**THT, latching, 2 coils (coils I and II are identical)**

3	2.25	8.55	2.25	69	130	V23026B1106B201	0-1393775-3
5	3.75	14.75	3.75	64	390	V23026B1101B201	3-1393774-4
9	6.75	26.00	6.75	68	1200	V23026B1105B201	0-1393775-2
12	9.00	29.00	9.00	96	1500	V23026B1102B201	3-1393774-5

24A nominal voltage of 24 V is feasible with a 12 V coil with a series resistor (1500  $\Omega$ )

**THT, latching, 1 coil**

3	2.25	13.00	2.25	30	300	V23026C1056B201	2-1393774-6
5	3.75	20.00	3.75	34	740	V23026C1051B201	2-1393774-0
9	6.75	35.00	6.75	38	2160	V23026C1057B201	2-1393774-7
12	9.00	50.00	9.00	32	4500	V23026C1052B201	2-1393774-1
24	18.00	50.00	18.00	128	4500	V23026C1054B201	2-1393774-4

**SMT, non-latching, 1 coil**

3	2.25	8.00	0.30	80	113	V23026D1026B201	0-1393776-8
5	3.75	13.30	0.50	80	313	V23026D1021B201	0-1393776-3
9	6.75	24.00	0.90	80	1015	V23026D1025B201	0-1422015-9
12	9.00	35.00	1.20	80	1800	V23026D1022B201	0-1393776-4
24	18.00	50.00	2.40	128	4500	V23026D1024B201	0-1393776-7

**SMT, latching, 2 coils (coils I and II are identical)**

3	2.25	8.55	2.25	69	130	V23026E1106B201	0-1393777-3
5	3.75	14.75	3.75	64	390	V23026E1101B201	0-1422015-6
9	6.75	26.00	6.75	68	1200	V23026E1105B201	0-1393777-2
12	9.00	29.00	9.00	96	1500	V23026E1102B201	0-1393776-9

24A nominal voltage of 24 V is feasible with a 12 V coil with a series resistor (1500  $\Omega$ )

**SMT, latching, 1 coil**

5	3.75	20.00	3.75	34	740	V23026F1051B201	0-1422015-8
12	9.00	50.00	9.00	32	4500	V23026F1052B201	4-1393774-3

24A nominal voltage of 24 V is feasible with a 12 V coil with a series resistor (4500  $\Omega$ )

Further coil versions e.g. 1.5 V, 9 V and 15 V are available on request.

**Coil operating range**

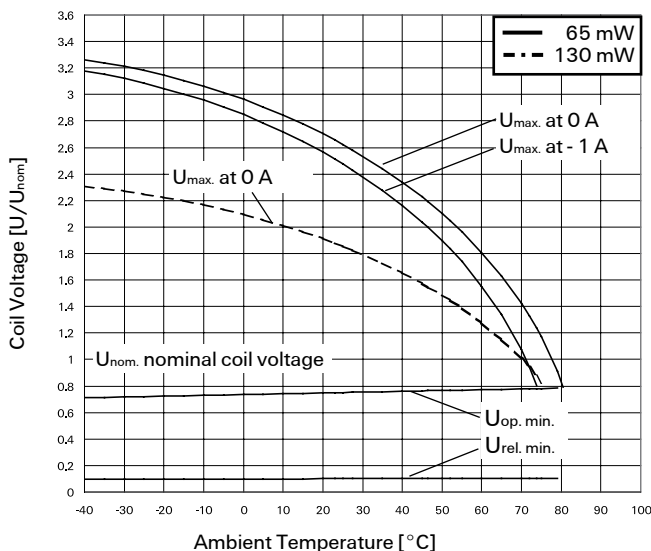

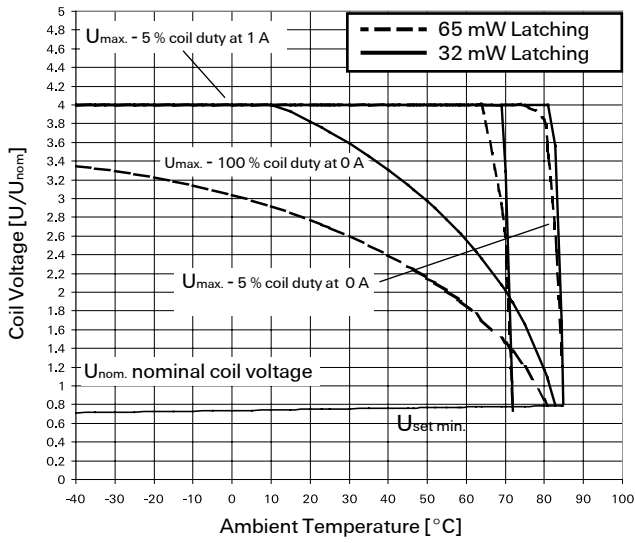

- $U_{nom}$  = Nominal coil voltage
- $U_{max}$  = Upper limit of the operative range of the coil voltage (limiting voltage) when coils are continuously energized
- $U_{op. min.}$  = Lower limit of the operative range of the coil voltage (reliable operate voltage)
- $U_{rel. min.}$  = Lower limit of the operative range of the coil voltage (reliable release voltage)

**Contact Data**

Number of contacts and type	1 changeover contact
Contact assembly	Bifurcated contact
Contact material	Palladium nickel, gold-rhodium covered
Limiting continuous current at max. ambient temperature	1 A
Maximum switching current	1 A
Maximum switching voltage	125 Vdc 150 Vac
Maximum switching capacity	30 W, 60 VA
Thermoelectric potential	< 100 $\mu$ V
Initial contact resistance / measuring condition: 10 mA / 20 mV	< 50 m $\Omega$
Electrical endurance	at 12 V / 10 mA: typ. $5 \times 10^7$ operations at 6 V / 100 mA: typ. $1 \times 10^7$ operations at 30 V / 1000 mA: typ. $1 \times 10^4$ operations
Mechanical endurance	typ. $10^8$ operations
UL/CSA ratings	30 Vdc / 1 A 65 Vdc / 0.46 A 150 Vac / 0.46 A

**Max. DC load breaking capacity**

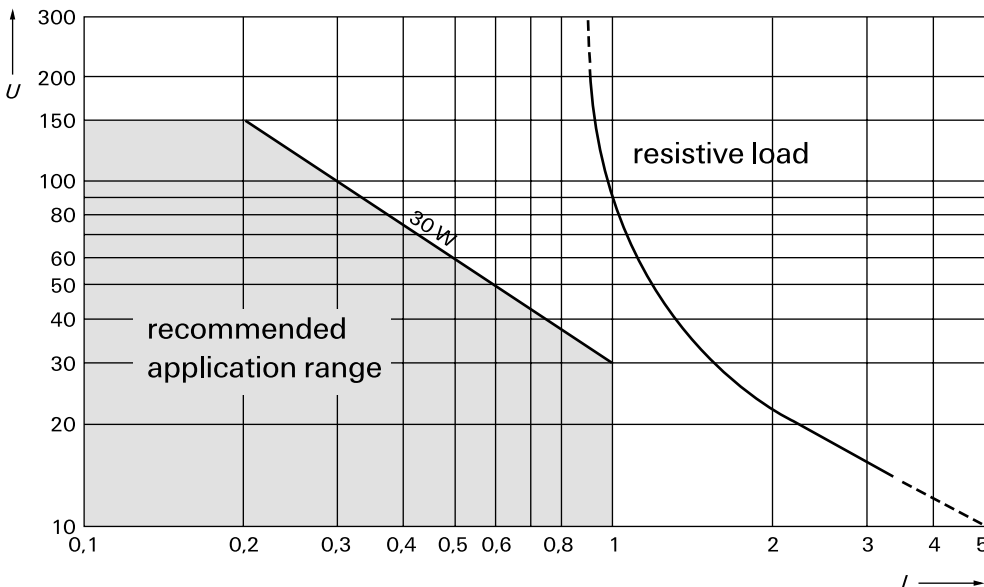

**Insulation**

Insulation resistance at 500 VDC	> 10 <sup>9</sup> Ω
Dielectric test voltage (1 min)	
between coil and contacts (Relay with 1 coil)	1500 Vrms
between open contacts	500 Vrms
Surge voltage resistance	
according to Bellcore TR-NWT-001089 (2 / 10 μs)	
between coil and contacts (Relay with 1 coil)	2500 V
between open contacts	on request 2000 V
according to FCC 68 (10 / 160 μs)	
between coil and contacts (Relay with 1 coil)	1500 V
between open contacts	on request 1500 V
Insulation according to IEC / EN 60950	Basic insulation
Clearance	0.75 mm
Creepage distance	0.75 mm

**High Frequency Data**

Capacitance	
between coil and contacts	max. 6 pF
between open contacts	max. 5 pF
RF Characteristics	
Isolation at 100 / 900 MHz	- 30.0 dB / - 18.0 dB
Insertion loss at 100 / 900 MHz	- 0.12 dB / - 1.9 dB
V.S.W.R. at 100 / 900 MHz	1.06 / 1.75

**General data**

Operate time at $U_{nom}$ typ. / max.	1 ms / 2 ms
Reset time (latching) at $U_{nom}$ , typ. / max.	1 ms / 2 ms
Release time without diode in parallel (non-latching), typ. / max.	0.4 ms / 1 ms
Release time with diode in parallel (non-latching), typ. / max.	1.2 ms / 2 ms
Bounce time at closing contact, typ. / max.	1 ms / 3 ms
Maximum switching rate without load	200 operations/s
Ambient temperature	-40° C ... +70° C, +85° C on request
Thermal resistance	< 130 K/W
Maximum permissible coil temperature	85° C
Vibration resistance (function)	20 G, 200 to 2000 Hz 40 G, 10 to 200 Hz
Shock resistance, half sinus, 11 ms	50 G (function)
Degree of protection / Environmental protection	immersion cleanable, IP 67 / RT III
Needle flame test	application time 20 s, burning time < 15 s
Mounting position	any
Processing information	Ultrasonic cleaning possible
Weight (mass)	max. 2 g
Terminal surface	SnCu 0.7
Resistance to soldering heat	260° C / 10 s

All data refers to 23° C unless otherwise specified.

### Recommended soldering conditions

Soldering conditions according CECC 00802

Note: Internal relay temperature should not exceed 210° C

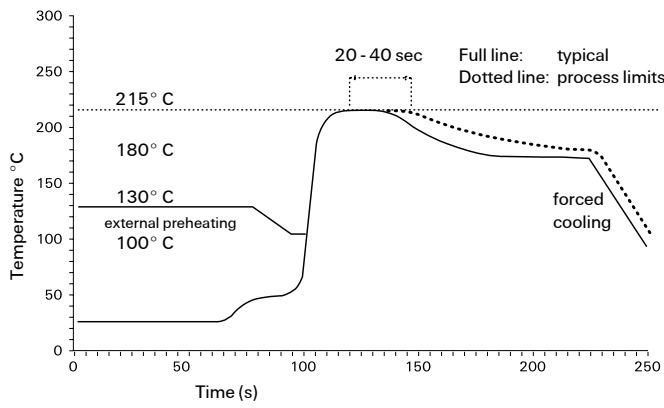

Vapor Phase Soldering: Temperature/Time Profile (Lead Temperature)

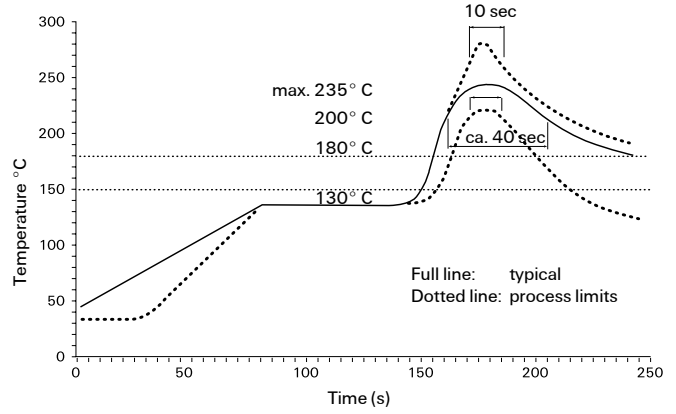

Infrared Soldering: Temperature/Time Profile (Lead Temperature)





## IM Relays

4<sup>th</sup> generation slim line – low profile polarized 2 c/o telecom relay with bifurcated contacts, available as non latching or latching relay with 1 coil. Nominal voltage range from 1.5... 24 V, coil power consumption of 140... 200 mW, latching relays with 1 coil 100 mW. The IM relay is available as through hole and surface mount type (J-Legs and Gull Wings) and capable to switch loads up to 60 W/62,5 VA. Dielectric strength fulfills the Bellcore requirements according GR 1089 (2,5 kV – 2 / 10 µs) and FCC part 68 (1,5 kV – 10 / 160 µs). The IM relay is CECC/IECQ approved and certified in accordance with IEC/EN 60950 and UL1950. Dimensions approx. 10 x 6 mm board space and 5,65 mm height.

## P2 Relays

3<sup>rd</sup> generation polarized 2 c/o telecom relay with bifurcated contacts, available as non latching or latching relay with 1 or 2 coils. Nominal voltage range from 3 ... 24 V, coil power consumption 140 mW, latching relays with 1 coil 70 mW. The P2 Relay is available as through hole or surface mount type and capable to switch currents up to 5 A. Dielectric strength fulfills the Bellcore requirements according GR 1089 (2,5 kV – 2 / 10 µs) and FCC part 68 (1,5 kV – 10 / 160 µs). Dimensions approx. 15 x 7,5 mm board space and 10 mm height.

## FX Relays

3<sup>rd</sup> generation polarized 2 c/o telecom relay with bifurcated contacts, available as non latching or latching relay with 1 coil. Nominal voltage range from 3 ... 48 V, coil power consumption of 80 ... 260 mW for the high sensitive version, 140... 300 mW for the standard version, latching relays with 1 coil 100 mW. The FX2 relay is available as through hole type and capable to switch loads up to 60 W/62,5 VA. Dielectric strength fulfills the Bellcore requirements according GR 1089 (2,5 kV – 2 / 10 µs) and FCC part 68 (1,5 kV – 10 / 160 µs). The FX2 is CECC/IECQ approved and certified in accordance with IEC/EN 60950 and UL1950. Dimensions approx. 15 x 7,5 mm board space and 10,7 mm height.

## FT2 / FU2 Relays

3<sup>rd</sup> generation non polarized, non latching 2 c/o telecom relay with bifurcated contacts. Nominal voltage range from 3 ... 48 V, coil power consumption 200 ... 300 mW. Most sensitive 48 V relay. Available as through hole and surface mount type. Dielectric strength fulfills the Bellcore requirements according GR 1089 (2,5 kV – 2 / 10 µs) and FCC part 68 (1,5 kV – 10 / 160 µs). The FT2/FU2 is CECC/IECQ approved and certified in accordance with IEC/EN 60950 and UL1950. Dimensions approx. 15 x 7,5 mm board space and 10 mm height.

## FP2 Relays

3<sup>rd</sup> generation polarized 2 c/o telecom relay with bifurcated contacts, available as non latching or latching relay with 1 or 2 coils. Nominal voltage range from 3 ... 48 V, coil power consumption of 80 ... 260 mW for the high sensitive version, 140... 300 mW for the standard version, latching relays with 1 coil 100 mW.. The FP2 Relay is available as through hole type and capable to switch loads up to 30 W/62,5 VA. Dielectric strength fulfills FCC part 68 (1,5 kV – 10 / 160 µs). The FP2 is CECC/IECQ approved. Dimensions approx. 14 x 9 mm board space and 5 mm height.

## MT2 / MT4

2<sup>nd</sup> generation non polarized, non latching 2 c/o and 4 c/o telecom and signal relay with bifurcated contacts. Nominal voltage range from 4.5 ... 48 V, coil power consumption 150/200/300/400 and 550 mW, and 300 mW (MT4). Dielectric strength fulfills the requirements according FCC part 68 (1,5 kV – 10 / 160 µs) for both and the Bellcore requirements according GR 1089 (2,5 kV – 2 / 10 µs) the MT4 only. Dimensions MT2 approx. 20 x 10 mm board space and 11 mm height, MT4 approx. 20 x 15 mm board space and 11 mm height.

## D2n Relays

2<sup>nd</sup> generation non polarized 2 c/o relay for telecom and various other applications. Nominal voltage range from 3 ... 48 V, coil power consumption from 150 ... 500 mW. The D2n relay is capable to switch currents up to 3 A. Dielectric strength fulfills the requirements according FCC part 68 (1,5 kV – 10 / 160 µs). Dimensions approx. 20 x 10 mm board space and 11,5 mm height.

## P1 Relays

Extremely sensitive, polarized 1 c/o relay with bifurcated contacts for a wide range of applications, available as non latching or latching relay with 1 or 2 coils. Nominal voltage range from 3 ... 24 V, coil power consumption 65 mW, latching relays with 1 coil 30 mW. The P1 relay is available as through hole or surface mount type and capable to switch currents up to 1 A. Dielectric strength fulfills the requirements according FCC part 68 (1,5 kV – 10 / 160 µs). Dimensions approx. 13 x 7,6 mm board space and 7 mm height for THT or 8 mm height for SMT version.

## W11 Relays

Low cost, non polarized 1 c/o relay for various applications. Nominal voltage range from 3 ... 24 V, coil power consumption 450 mW, sensitive versions 200 mW. The W11 relay is capable to switch currents up to 3 A. Dielectric strength 1000 Vrms. Dimensions approx. 15,6 x 10,6 mm board space and 11,5 mm height.

## Reed Relays

High sensitive, non polarized relay for telecom and various other applications, available with 1 n/o, 2 n/o or 1c/o contacts. Nominal voltage range from 5 ... 24 V, coil power consumption 50...280 mW for 1 n/o and 125 ... 280 mW for 2 n/o or 1 c/o versions. Reedrelays are available in DIP or SIL housing and capable to switch currents up to 0,5 A. Integrated diode and/or electrostatic shield optional. Dielectric strength 1500 Vdc. Dimensions approx. 19,3 x 7 mm board space and 5 ... 7,5 mm height for DIP or 19,8 x 5 mm board space and 7,8 mm height for SIL version.

## Cradle Relays

Extremely reliable and mature relay family of 1<sup>st</sup> generation for various signal switching applications. Available as non polarized, polarized / latching and relay with AC coil. The benefit is the possibility of combining various contact sets from 1 up to 6 poles, single and bifurcated contacts, different contact materials with a coil voltage range from 1,5 Vdc to 220 Vac. Cradle relays are available as dust protected and hermetically sealed versions, with plug in or solder terminals and are capable to switch currents up to 5 A. Forcibly terminated (linked) contact sets optional. Dielectric strength 500 Vrms. Dimensions from approx. 19 x 24 to 19x35 mm board space and 30 mm height.

## Other Relays

We offer a variety of different relay families for maintenance and replacement purposes. These relays are up to 60 years old now, such as Card Relay SN (V23030 / V23031 series), Small General Purpose Relay (V23006 series), Small Polarized Relay (V23063 ... V23067 and V23163 ... V23167 series). Accessories like sockets, hold down springs, etc. optional.

## HF3 Relay

High performance low cost RF relay with excellent RF characteristics. Available with an impedance of 50 and 75 Ohm. Suitable for frequencies up to 3 GHz. Actually smallest RF relay available combining small size, excellent RF performance and SMD solderability. Available as non latching or latching relay with 1 or 2 coils and a nominal coil voltage range from 3 ... 24 V, coil power consumption 140 mW, latching relays with 1 coil 70 mW. Dimensions 14,6 x 7,3 x 10 mm.



Tyco Electronics AXICOM Ltd.  
Seestrasse 295 - P.O. Box 220  
CH-8804 Au-Wädenswil / Switzerland  
Phone +41 1 782 9111  
Fax +41 1 782 9080  
E-mail: [axicom@tycoelectronics.com](mailto:axicom@tycoelectronics.com)



Tyco Electronics  
Paulsternstrasse 26  
D-13629 Berlin / Germany  
Phone +49 30 386 38573  
Fax +49 30 386 38575  
E-mail: [axicom@tycoelectronics.com](mailto:axicom@tycoelectronics.com)



Tyco Electronics EC Trutnov s.r.o.  
Komenského 821  
CZ-541 01 Trutnov / Czech Republic  
E-mail: [axicom@tycoelectronics.com](mailto:axicom@tycoelectronics.com)

Tyco Electronics Corporation  
POB 3608,  
Harrisburg, PA 17105, USA  
Phone +001 800-522-6752