





- Cadmium - free contacts • Height 15,7 mm • 5000 V / 10 mm reinforced insulation • **Coil terminals for PCB, contacts terminals for PCB and flat insert connectors - faston 250 (6,3 x 0,8 mm), faston arrangement: vertical version (V) and horizontal version (H)** • DC coils - sensitive
- Ambient temperature up to 105 °C • Applications: for control of operation of heating elements and motors of household equipment and catering industry devices, for control of electromagnetic valves, in many other applications • Compliance with standard PN-EN 60335-1
- Recognitions, certifications, directives: RoHS,    

Contact data

Number and type of contacts	1 NO	
Contact material	AgSnO₂	
Rated / max. switching voltage	AC	250 V / 440 V
Min. switching voltage	10 V	
Rated load (capacity)	AC1	20 A / 250 V AC
	AC15	3 A / 120 V 1,5 A / 240 V (B300)
	AC3	750 W (single-phase motor)
	DC1	20 A / 24 V DC
	DC13	0,22 A / 120 V 0,1 A / 250 V (R300)
Min. switching current	10 mA	
Max. inrush current	30 A	
Rated current	20 A	
Max. breaking capacity	AC1	5 000 VA
Min. breaking capacity	1 W	
Contact resistance	≤ 100 mΩ 100 mA, 24 V	
Max. operating frequency	AC1	• at rated load 600 cycles/hour
		• no load 72 000 cycles/hour

Coil data

Rated voltage	DC	5 ... 48 V
Must release voltage	DC: ≥ 0,1 U _n	
Operating range of supply voltage	see Table 1	
Rated power consumption	DC	0,25 W

Insulation according to PN-EN 60664-1

Insulation rated voltage	400 V AC	
Rated surge voltage	4 000 V 1,2 / 50 μs	
Overtoltage category	III	
Insulation pollution degree	3	
Dielectric strength	• between coil and contacts	5 000 V AC type of insulation: reinforced
	• contact clearance	1 000 V AC type of clearance: micro-disconnection
Contact - coil distance	• clearance	≥ 10 mm
	• creepage	≥ 10 mm

General data

Operating / release time (typical values)	8 ms / 3 ms	
Electrical life (number of cycles)	• resistive AC1	> 2 x 10 ⁴ 20 A, 250 V AC, 85 °C > 1,5 x 10 ⁵ 10 A, 250 V AC, 105 °C
	• cos φ	see Fig. 1
Mechanical life (cycles)	> 3 x 10 ⁷	
Dimensions (L x W x H)	vertical version (V): 40,5 x 12,7 x 15,7 mm horizontal version (H): 44,5 x 12,7 x 15,7 mm	
Weight	16 g	
Ambient temperature	• storage	-40...+105 °C
	• operating	-40...+105 °C
Cover protection category	IP 40	PN-EN 60529
Environmental protection	RTII	PN-EN 116000-3
Shock resistance	30 g	
Vibration resistance	10 g 10...150 Hz	
Solder bath temperature	max. 270 °C	
Soldering time	max. 5 s	

The data in bold type pertain to the standard versions of the relays.

Coil data - DC voltage version, sensitive version

Table 1

Coil code	Rated voltage V DC	Coil resistance at 20 °C Ω	Acceptable resistance	Coil operating range V DC	
				min. (at 20 °C)	max. (at 20 °C)
S005	5	102	± 10%	3,75	15,0
S006	6	144	± 10%	4,50	18,0
S009	9	330	± 10%	6,75	27,0
S010	10	380	± 10%	7,50	30,0
S012	12	580	± 10%	9,00	36,0
S018	18	1 300	± 10%	13,50	54,0
S024	24	2 300	± 10%	18,00	72,0
S048	48	9 340	± 10%	36,00	144,0

The data in bold type pertain to the standard versions of the relays.

Dimensions

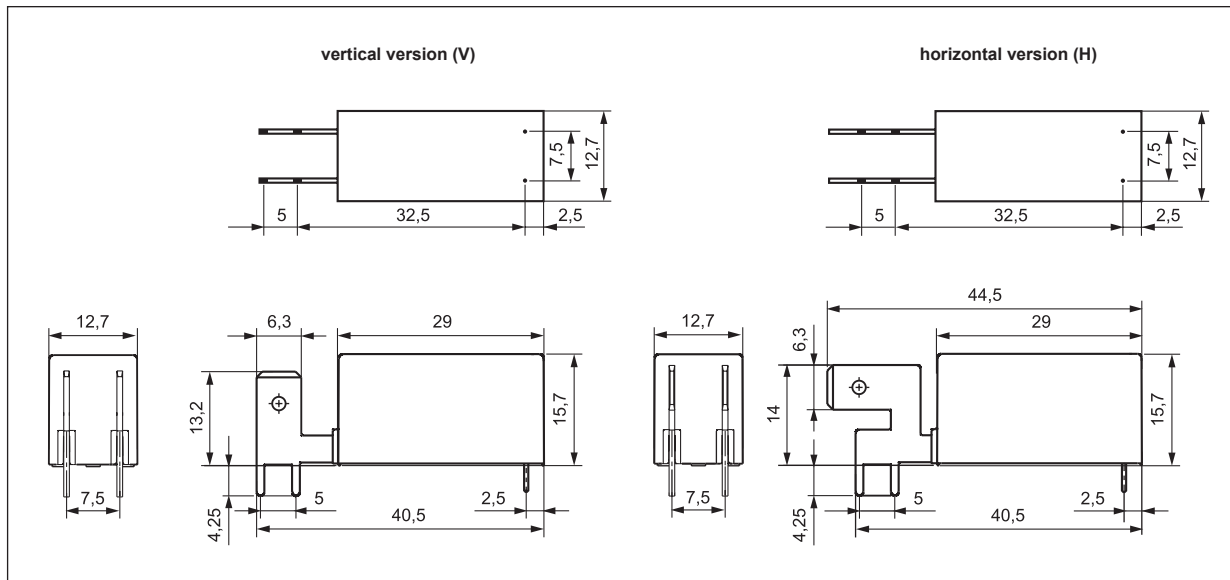

Connection diagram (pin side view)

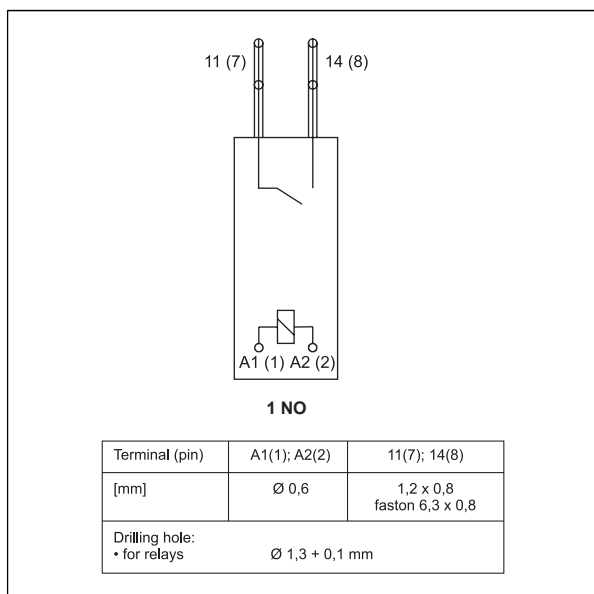

Electrical life reduction factor at AC inductive load

Fig. 1

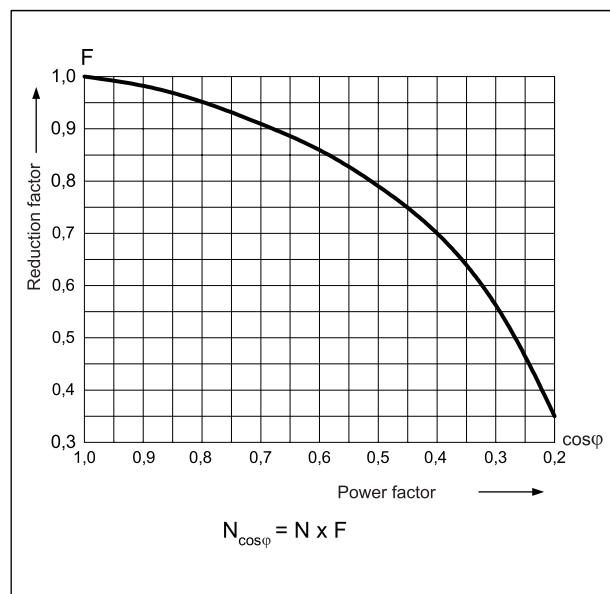

Pinout (solder side view)

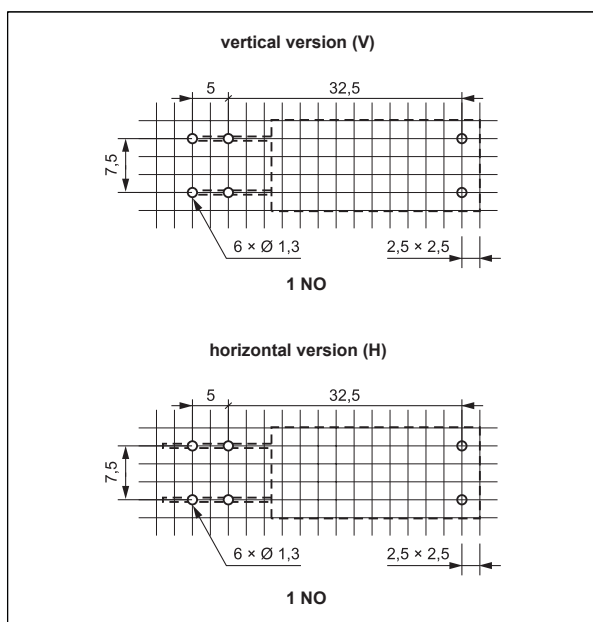

Mounting

Relays **RM85 faston** are designed for: • direct PCB mounting • connection of load with flat insert connectors - faston 250 (6,3 x 0,8 mm).

Ordering codes

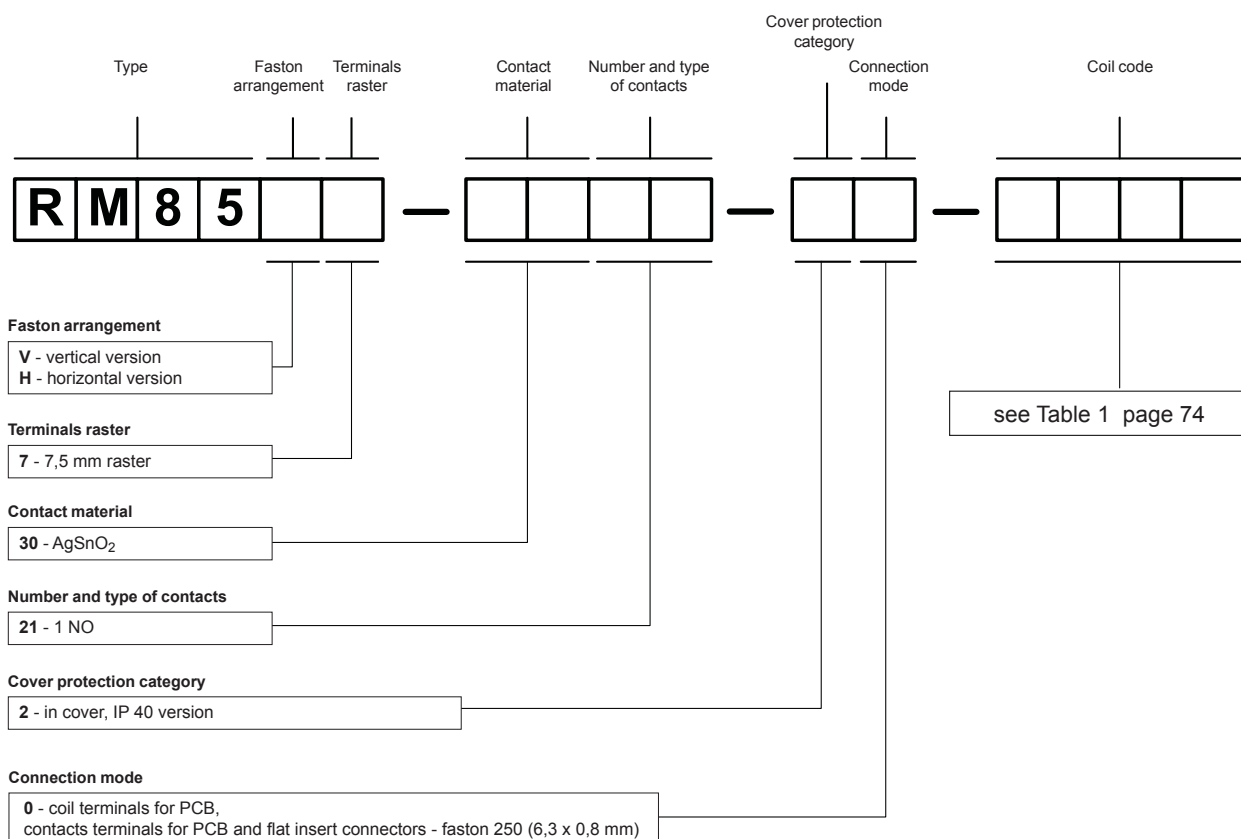

Example of ordering code:

RM85V7-3021-20-S012

relay **RM85 faston**, vertical version, 7,5 mm terminals raster, contact material AgSnO₂, with one normally open contact, in cover IP 40, coil terminals for PCB, contacts terminals for PCB and flat insert connectors - faston 250 (6,3 x 0,8 mm), sensitive voltage version 12 V DC