



»» Features

- 25A miniature general purpose Power Relay.
- With or without quick terminal & PCB terminal.
- CSA/CUS, TUV,UL/CUL approved.
- Designed for compressor load switching application and office equipment of motor control or lamp load switching.
- Comply with RoHS-Directive 2002/95/EC.

»» Type List

Terminal style	Contact form	Designation
WP (Quick terminal & PCB terminal)	SPNO	891WP-1A-C
P (PCB terminal)	SPNO	891P-1A-C

»» Ordering Information

891 WP - 1A - F - C
 1 2 3 4 5

- | | | | |
|--------|-----------------------------------|----------|------------------|
| 1. 891 | -- Basic series designation | 4. Blank | -- Standard type |
| | | F | -- Class F |
| 2. P | -- PCB terminal | | |
| WP | -- Socket terminal & PCB terminal | 5. C | -- Flux tight |
| 3. 1A | -- Single pole normally open | | |

»» Contact Rating

Resistive load	25A 250VAC
Inductive load / Compressor load	Inrush 80A 240VAC $\cos\phi 0.7$ Steady state 20A 240VAC $\cos\phi 0.9$

»» Coil Rating (DC)

Rated voltage (V)	Rated current $\pm 10\%$ at 23°C (mA)	Coil resistance $\pm 10\%$ at 23°C (Ω)	Max. continuous voltage at 85°C	Pick up voltage(Max) at 23°C	Drop out voltage(Min) at 23°C	Power consumption at rated voltage
5	180	27.8	150 % of rated voltage	75 % of rated voltage	10 % of rated voltage	approx. 0.9W
6	150	40				
9	100	90				
12	75	160				
24	38	640				
48	19	2560				

»» Specification

Contact material	AgSnO alloy	
Contact resistance ⁽¹⁾	100mΩ Max.	
Operate time ⁽¹⁾	20ms Max.	
Release time ⁽¹⁾	10ms Max.	
Insulation resistance ⁽¹⁾	1000 MΩ Min. (DC 500V)	
Dielectric strength ⁽¹⁾	Between open contact	: AC 1000V , 50/60Hz 1 min.
	Between contact and coil	: AC 4500V , 50/60Hz 1 min.
Vibration resistance	Operating extremes	10~55Hz , amplitude 1.5 mm
	Damage limits	10~55Hz , amplitude 2.0 mm
Shock resistance	Operating extremes	10G
	Damage limits	100G
Life expectancy	Mechanical	5,000,000 operations (frequency 18,000 operations/hr)
	Electrical	100,000 operations (frequency 360 operations/hr)
Operating ambient temperature	-40~+ 85°C (no freezing)	
Weight	Approx. 22g	

Note : (1) initial value

»» Safety Approval

Certified	CSA / CUS	TUV	UL / CUL
File No.	1165173	R3-50003966	E88991

»» Safety Approval Rating

CSA / CUS	TUV	UL / CUL
25A 277VAC 1.5HP 125/250VAC	25A 250VAC 20A 250VAC cos φ0.7	25A 277VAC 1.5HP 125VAC/250VAC 18FLA/98LRA 240VAC

»» Outline Dimensions

◆ 891P

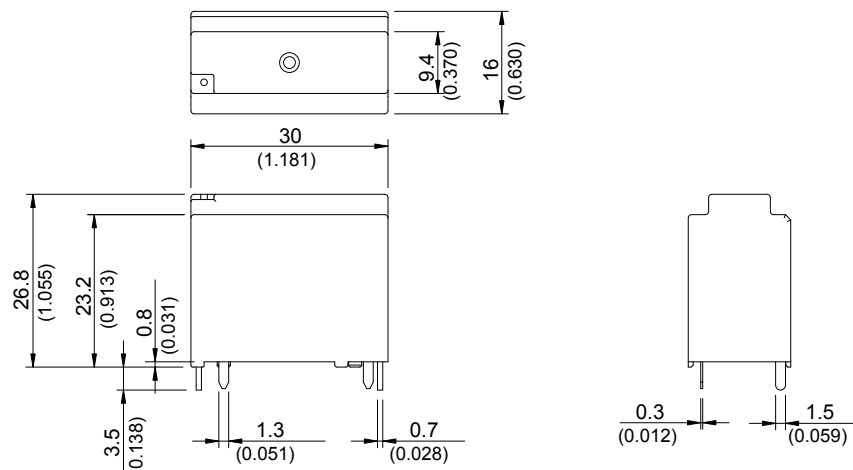

◆ 891WP

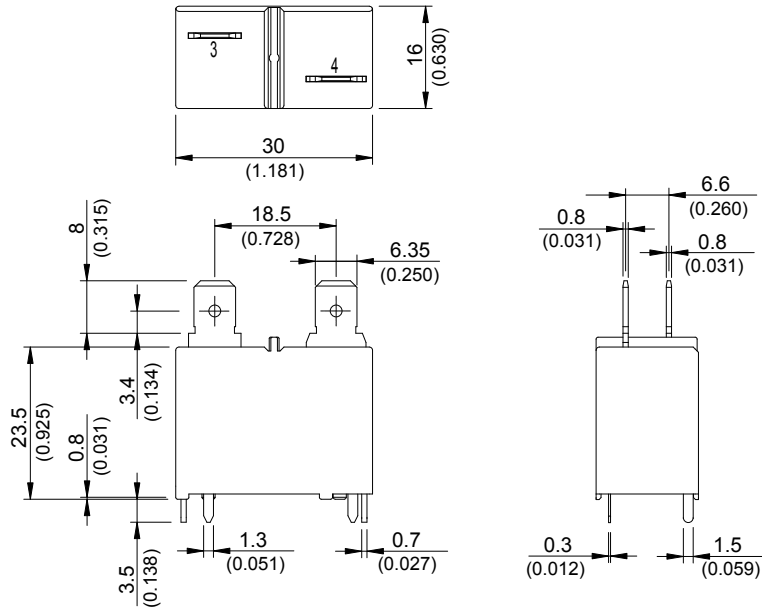

»» Wiring Diagram
 BOTTOM VIEW

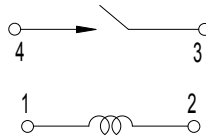

»» PC Board Layout
 BOTTOM VIEW

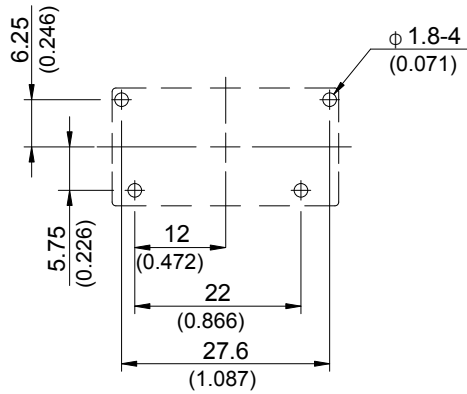

»» Engineering Data

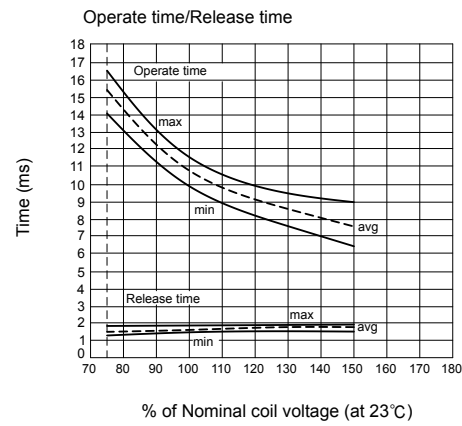
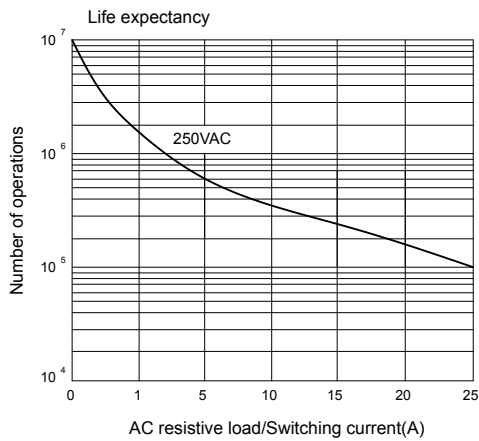
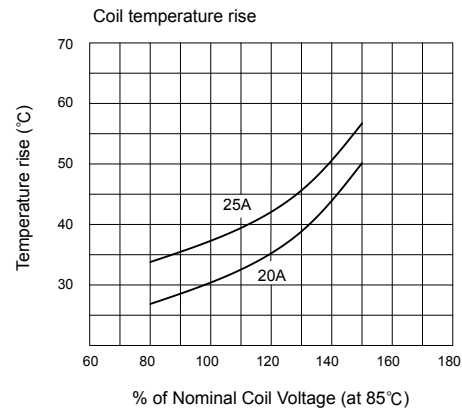
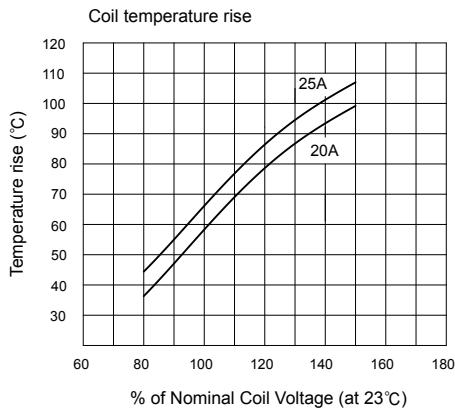

Mouser Electronics

Authorized Distributor

Click to View Pricing, Inventory, Delivery & Lifecycle Information:

Song Chuan:

[891WP-1A-C12VDC](#) [891WP-1A-C24VDC](#)