

Features

Printed circuit mount 12 A Power relay

- 2 & 4 pole
- AC coils & DC coils
- Cadmium Free contacts (standard version)
- Contact material option
- RT III (wash tight) option available

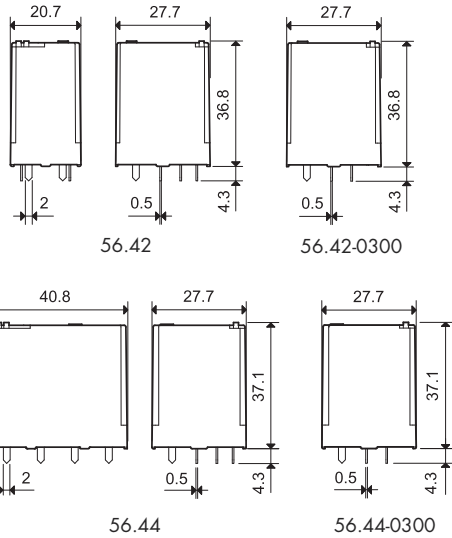

* For 4 CO (4PDT) or 4 NO only.
FOR UL HORSEPOWER AND PILOT DUTY RATINGS
SEE "General technical information" page V

56.42/56.44



- 2 or 4 pole changeover contact
- PCB mount

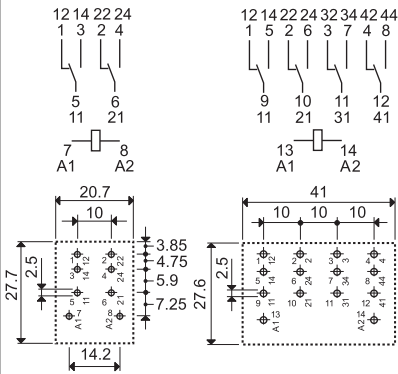

56.42 Copper side view 56.44 Copper side view

56.42-0300/56.44-0300



- 2 or 4 pole normally open contact (≥ 1.5 mm gap)
- PCB mount

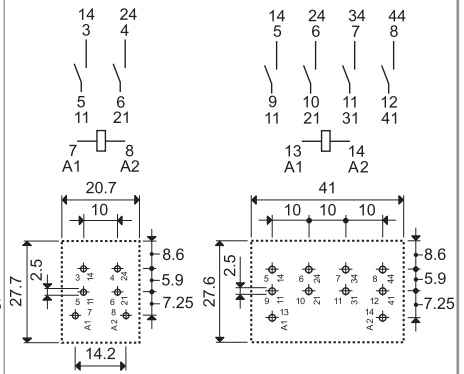

56.42-0300 Copper side view 56.44-0300 Copper side view

Contact specification		2 CO (DPDT)		4 CO (4PDT)		2NO (DPSTNO) - ≥1.5mm gap		4NO (4PSTNO) - ≥1.5mm gap	
Contact configuration									
Rated current/Maximum peak current	A	12/20		12/20		12/20		12/20	
Rated voltage/Maximum switching voltage	V AC	250/400		250/400		250/400		250/400	
Rated load AC1	VA	3,000		3,000		3,000		3,000	
Rated load AC15 (230 V AC)	VA	700		700		700		700	
Single phase motor rating (230 V AC)	kW	0.55		0.55		0.55		0.55	
Breaking capacity DC1: 30/110/220 V	A	12/0.5/0.25		12/0.5/0.25		12/1/0.5		12/1/0.5	
Minimum switching load	mW (V/mA)	500 (10/5)		500 (10/5)		500 (10/5)		500 (10/5)	
Standard contact material		AgNi		AgNi		AgNi		AgNi	
Coil specification									
Nominal voltage (U _N)	V AC (50/60 Hz)	6 - 12 - 24 - 48 - 60 - 110 - 120 - 230 - 240 - 400*							
	V DC	6 - 12 - 24 - 48 - 60 - 110 - 125 - 220				-			
Rated power AC/DC	VA (50 Hz)/W	1.5/1		2/1.3		1.5/-		2/-	
Operating range	AC	(0.8...1.1)U _N				(0.85...1.1)U _N			
	DC	(0.8...1.1)U _N		(0.85...1.1)U _N		-			
Holding voltage	AC/DC	0.8 U _N /0.6 U _N				0.85 U _N /-			
Must drop-out voltage	AC/DC	0.2 U _N /0.1 U _N				0.2 U _N /-			
Technical data									
Mechanical life AC/DC	cycles	20 · 10 ⁶ /50 · 10 ⁶				20 · 10 ⁶ /-			
Electrical life at rated load AC1	cycles	100 · 10 ³				100 · 10 ³			
Operate/release time	ms	8/8				8/4			
Insulation between coil and contacts (1.2/50 μs)	kV	4		5		4		5	
Dielectric strength between open contacts	V AC	1,000				2,000			
Ambient temperature range	°C	-40...+70				-40...+70			
Environmental protection		RT I				RT I			
Approvals (according to type)									

Ordering information

Example: 56 series plug-in relay, 2 CO (DPDT), 12 V DC coil, lockable test button and mechanical indicator.

5	6	.	3	.	2	.	9	.	0	1	2	.	0	A	0	B	0	C	4	D	0					
Series			Type			No. of poles			Coil version			Coil voltage			A: Contact material			B: Contact circuit			C: Options			D: Special versions		
			3 = Plug-in 4 = PCB			2 = 2 pole, 12 A 4 = 4 pole, 12 A			8 = AC (50/60 Hz) 9 = DC			See coil specifications			0 = Standard AgNi 2 = AgCdO 4 = AgSnO ₂			0 = CO (nPDT) 3 = NO (nPST), ≥ 1.5 mm contact gap			0 = None 2 = Mechanical indicator 3* = LED (AC) 4 = Lockable test button+mechanical indicator 5* = Lockable test button + LED (AC) 54* = Lockable test button + LED (AC) + mechanical indicator 6* = Double LED (DC non-polarized) 7* = Lockable test button + double LED (DC non-polarized) 74* = Lockable test button + double LED (DC non-polarized) + mechanical indicator 8* = LED + diode (DC, polarity positive to pin 7) for 56.32 only 9* = Lockable test button + LED + diode (DC, polarity positive to pin 7) for 56.32 only 94* = Lockable test button + LED + diode (DC, polarity positive to pin 7) + mechanical indicator for 56.32 only			0 = Standard 1 = Wash tight (RT III) for 56.42 and 56.44 only 6 = Rear flange mount (4 pole only) 8 = Rear 35 mm rail mount (4 pole only) For other mounting options see page 6		

Selecting features and options: only combinations in the same row are possible.
Preferred selections for best availability are shown in **bold**.

Type	Coil version	A	B	C	D
56.32	AC	0 - 2 - 4	0	0 - 2 - 3 - 4 - 5	0
	AC	0 - 2 - 4	0	54	/
	AC	0 - 2 - 4	3	0 - 3 - 5	0
	DC	0 - 2 - 4	0	0 - 2 - 4 - 6 - 7 - 8 - 9	0
	DC	0 - 2 - 4	0	74 - 94	/
56.34	AC	0 - 2 - 4	0	0 - 2 - 3 - 4 - 5	0 - 6 - 8
	AC	0 - 2 - 4	0	54	/
	AC	0 - 2 - 4	0 - 3	0 - 3 - 5	0
	DC	0 - 2 - 4	0	0 - 2 - 4 - 6 - 7	0 - 6 - 8
	DC	0 - 2 - 4	0	74	/
56.42	DC	0 - 2 - 4	0	0	0 - 1
	AC	0 - 2 - 4	0 - 3	0	0 - 1
56.44	AC-DC	0 - 2 - 4	0	0	0 - 1
	AC	0 - 2 - 4	0 - 3	0	0 - 1

Special versions for Rail Applications on request

Descriptions: options and special versions

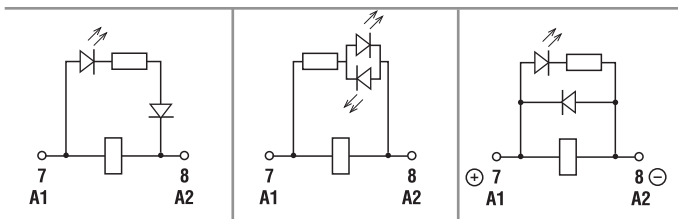

C: Option 3, 5, 54
LED (AC)

C: Option 6, 7, 74
Double LED (DC non-polarized)

C: Option 8, 9, 94
LED + diode (DC, polarity positive to pin 7) - (56.32 only)

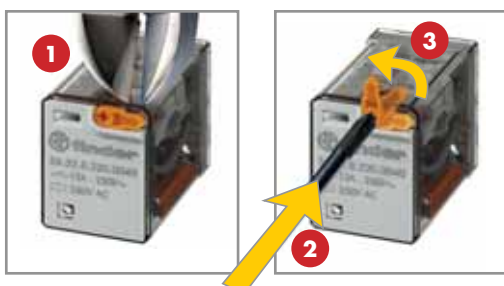

Lockable test button and mechanical flag indicator (0040, 0050, 0054, 0070, 0074, 0090, 0094)

The dual-purpose Finder test button can be used in two ways:

Case 1) The plastic pip (located directly above the test button) remains intact. In this case, when the test button is pushed, the contacts operate. When the test button is released the contacts return to their former state.

Case 2) The plastic pip is broken-off (using an appropriate cutting tool). In this case, (in addition to the above function), when the test button is pushed and rotated, the contacts are latched in the operating state, and remain so until the test button is rotated back to its former position.

In both cases ensure that the test button actuation is swift and decisive.

Technical data

*Only in applications where over voltage category II is permitted. In applications of over voltage category III: Micro-disconnection.

Insulation according to EN 61810-1		2 CO - 4 CO		2 NO - 4 NO	
Nominal voltage of supply system	V AC	230/400		230/400	
Rated insulation voltage	V AC	250	400	250	400
Pollution degree		3	2	3	2
Insulation between coil and contact set					
Type of insulation		Basic		Basic	
Overvoltage category		III		III	
Rated impulse voltage	kV (1.2/50 μs)	4		4	
Dielectric strength	V AC	2,500		2,500	
Insulation between adjacent contacts					
Type of insulation		Basic		Basic	
Overvoltage category		III		III	
Rated impulse voltage	kV (1.2/50 μs)	4		4	
Dielectric strength	V AC	2,500		2,500	
Insulation between open contacts					
Type of disconnection		Micro-disconnection		Full-disconnection*	
Overvoltage category		—		II	
Rated impulse voltage	kV (1.2/50 μs)	—		2.5	
Dielectric strength	V AC/(1.2/50 μs)	1,000/1.5		2,000/3	
Conducted disturbance immunity					
Burst (5...50) ns, 5 kHz, on A1 - A2		EN 61000-4-4		level 4 (4 kV)	
Surge (1.2/50 μs) on A1 - A2 (differential mode)		EN 61000-4-5		level 4 (4 kV)	
Other data					
Bounce time: NO/NC	ms	1/3 (changeover)		3/— (normally open)	
Vibration resistance (10...150 Hz): NO/NC	g	17/14			
Shock resistance NO/NC	g	20/14			
Power lost to the environment	without contact current	W	1 (56.32, 56.42)		1.3 (56.34, 56.44)
	with rated current	W	3.8 (56.32, 56.42)		6.9 (56.34, 56.44)
Recommended distance between relays mounted on PCB	mm	≥ 5			

Contact specification

F 56 - Electrical life (AC) v contact current
2 - 4 pole relays

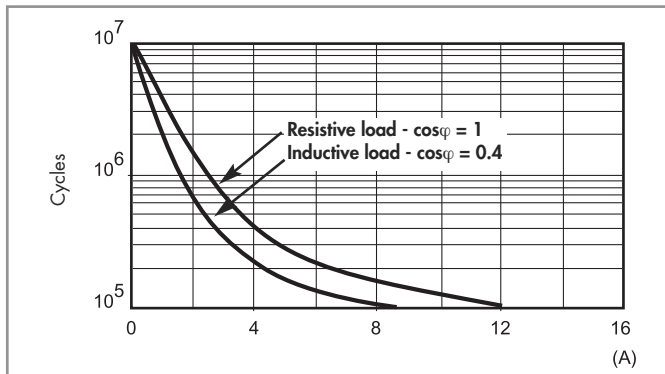

H 56 - Maximum DC1 breaking capacity
Changeover version

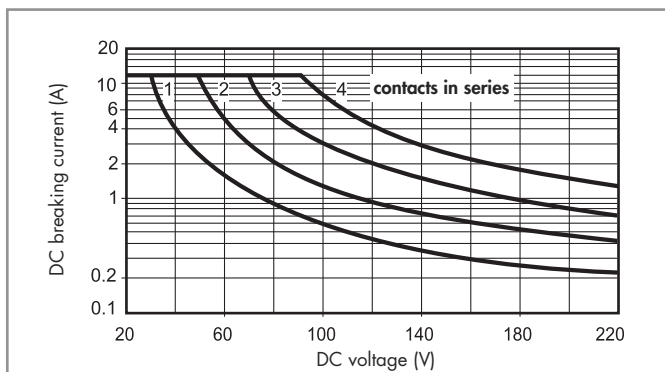

H 56 - Maximum DC1 breaking capacity
Normally open version

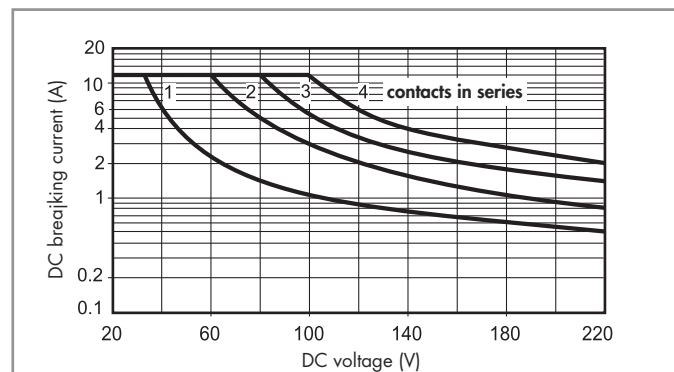

- When switching a resistive load (DC1) having voltage and current values under the curve, an electrical life of $\geq 100 \cdot 10^3$ can be expected.
- In the case of DC13 loads, the connection of a diode in parallel with the load will permit a similar electrical life as for a DC1 load.
Note: the release time of the load will be increased.

Coil specifications

DC coil data, 2 pole relay

Nominal voltage U_N V	Coil code	Operating range		Resistance R Ω	Rated coil consumption I at U_N mA
		U_{min} V	U_{max} V		
6	9.006	4.8	6.6	40	150
12	9.012	9.6	13.2	140	86
24	9.024	19.2	26.4	600	40
48	9.048	38.4	52.8	2,400	20
60	9.060	48	66	4,000	15
110	9.110	88	121	12,500	8.8
125	9.125	100	138	17,300	7.2
220	9.220	176	242	54,000	4

AC coil data, 2 pole relay

Nominal voltage U_N V	Coil code	Operating range		Resistance R Ω	Rated coil consumption I at U_N (50Hz) mA
		U_{min}^* V	U_{max} V		
6	8.006	4.8	6.6	12	200
12	8.012	9.6	13.2	50	97
24	8.024	19.2	26.4	190	53
48	8.048	38.4	52.8	770	25
60	8.060	48	66	1,200	21
110	8.110	88	121	3,940	12.5
120	8.120	96	132	4,700	12
230	8.230	184	253	17,000	6
240	8.240	192	264	19,100	5.3

* $U_{min} = 0.85 U_N$ for normally open version.

DC coil data, 4 pole relay

Nominal voltage U_N V	Coil code	Operating range		Resistance R Ω	Rated coil consumption I at U_N mA
		U_{min} V	U_{max} V		
6	9.006	5.1	6.6	32.5	185
12	9.012	10.2	13.2	123	97
24	9.024	20.4	26.4	490	49
48	9.048	40.8	52.8	1,800	27
60	9.060	51	66	3,000	20
110	9.110	93.5	121	10,400	10.5
125	9.125	107	138	14,200	8.8
220	9.220	187	242	44,000	5

AC coil data, 4 pole relay or 4 NO

Nominal voltage U_N V	Coil code	Operating range		Resistance R Ω	Rated coil consumption I at U_N (50Hz) mA
		U_{min}^* V	U_{max} V		
6	8.006	4.8	6.6	5.7	300
12	8.012	9.6	13.2	22	150
24	8.024	19.2	26.4	81	90
48	8.048	38.4	52.8	380	37
60	8.060	48	66	600	30
110	8.110	88	121	1,900	16.5
120	8.120	96	132	2,560	13.4
230	8.230	184	253	7,700	9
240	8.240	192	264	10,000	7.5
400	8.400	320	440	26,000	4.9

* $U_{min} = 0.85 U_N$ for normally open version.

R 56 - DC coil operating range v ambient temperature
2 pole relay

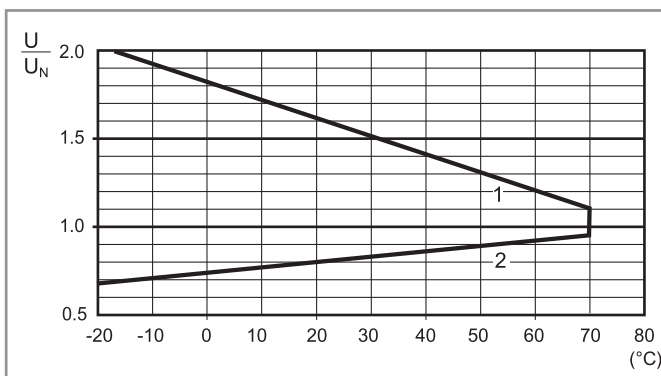

R 56 - AC coil operating range v ambient temperature
2 pole relay

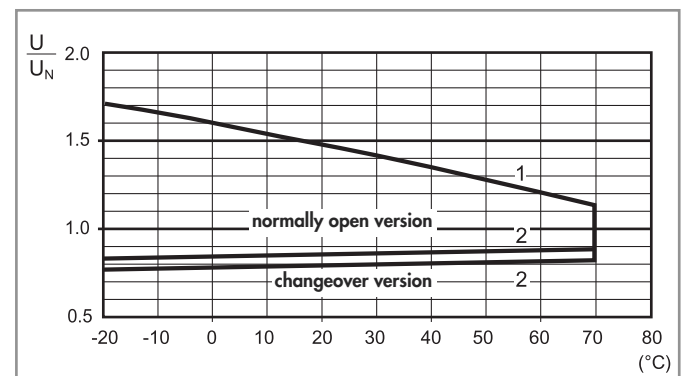

R 56 - DC coil operating range v ambient temperature
4 pole relay

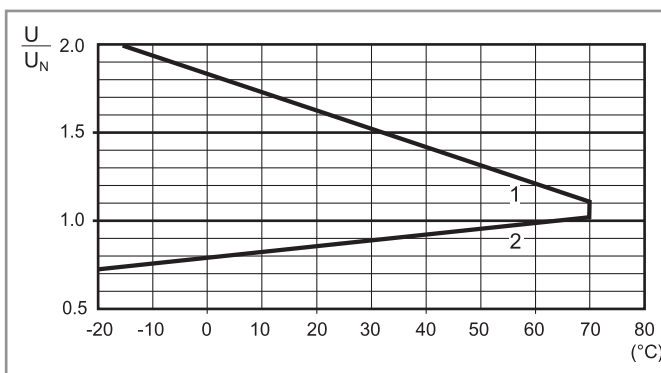

R 56 - AC coil operating range v ambient temperature
4 pole relay or 4 NO

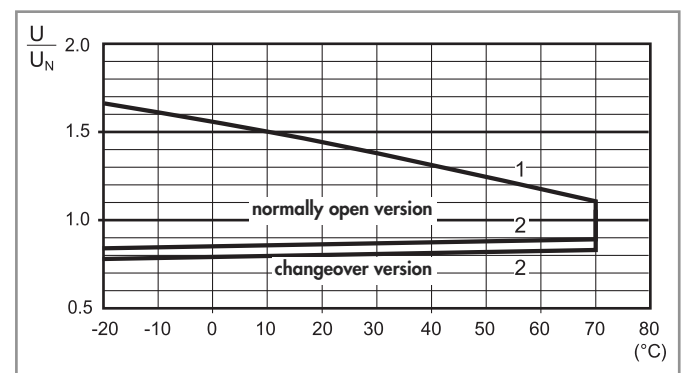

1 - Max. permitted coil voltage.
2 - Min. pick-up voltage with coil at ambient temperature.

1 - Max. permitted coil voltage.
2 - Min. pick-up voltage with coil at ambient temperature.

Accessories



056.25

056.25 with relay

Top flange mount adaptor for 56.32

056.25

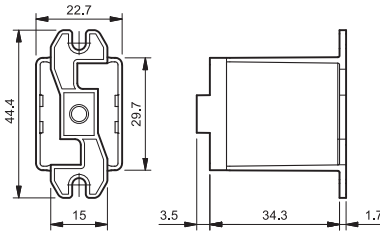

056.25

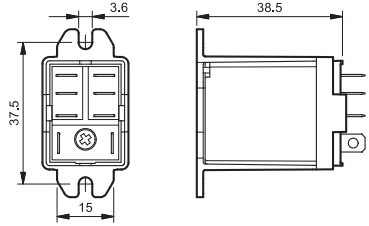

056.25 with relay



056.26

056.26 with relay

Rear flange mount adaptor for 56.32

056.26

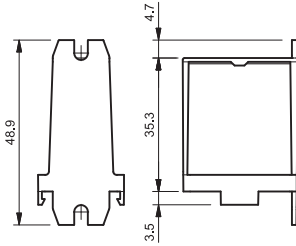

056.26

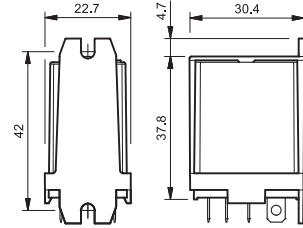

056.26 with relay



056.27

056.27 with relay

Top 35 mm rail (EN 60715) adaptor for 56.32

056.27

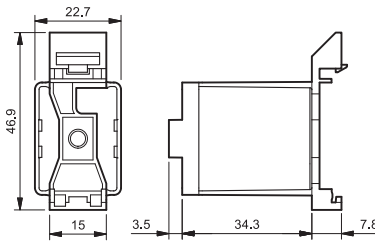

056.27

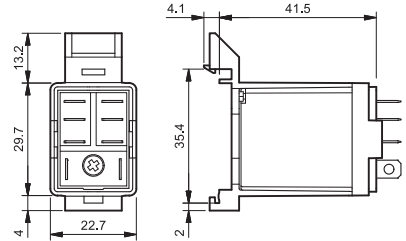

056.27 with relay



056.45

056.45 with relay

Top flange mount adaptor for 56.34

056.45

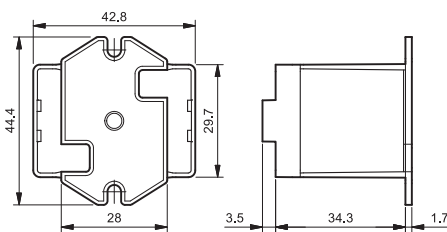

056.45

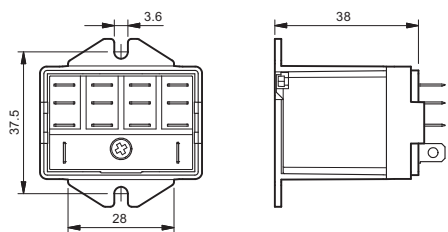

056.45 with relay



056.47

056.47 with relay

Top 35 mm rail (EN 60715) adaptor for 56.34

056.47

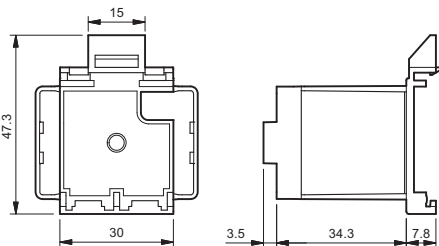

056.47

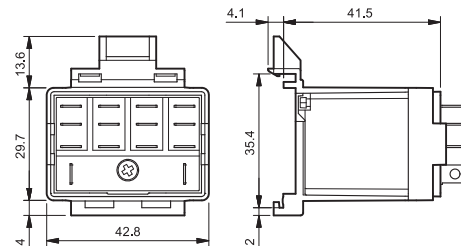

056.47 with relay

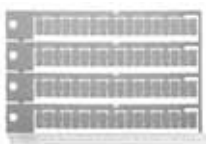

060.72

Sheet of marker tags for relay type 56.34, plastic, 72 tags, 6x12 mm

060.72

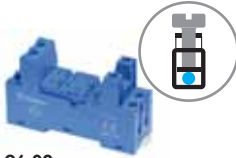

96.02
Approvals
(according to type):

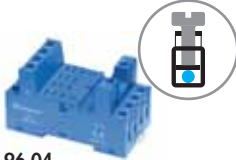

96.04
Approvals
(according to type):



094.91.3

Screw terminal (Box clamp) socket panel or 35 mm (EN 60715) rail mount	96.02 Blue	96.02.0 Black	96.04 Blue	96.04.0 Black
For relay type	56.32		56.34	
Accessories				
Metal retaining clip (supplied with socket - packaging code SMA)	094.71		096.71	
Plastic retaining and release clip (supplied with socket - packaging code SPA)	094.91.3	094.91.30	—	—
6-way jumper link	094.06	094.06.0	—	—
Identification tag	095.00.4		090.00.2	
Modules (see table below)	99.02			
Timer modules (see table below)	86.30		86.00, 86.30	
Sheet of marker tags for retaining and release clip 094.91.3 plastic, 72 tags, 6x12 mm	060.72		—	
Technical data				
Rated values	12 A - 250 V			
Dielectric strength	2 kV AC			
Protection category	IP 20			
Ambient temperature	°C -40...+70 (see diagram L96)			
⊕ Screw torque	Nm	0.8		
Wire strip length	mm	8		
Max. wire size for 94.02/04 sockets		solid wire	stranded wire	
	mm ²	1x6 / 2x2.5		1x4 / 2x2.5
	AWG	1x10 / 2x14		1x12 / 2x14

L 96 - Rated current vs ambient temperature

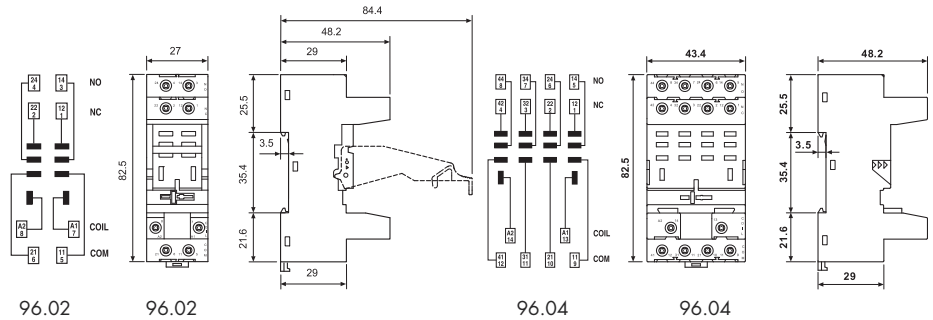
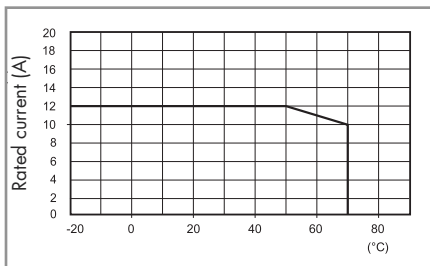

094.06

6-way jumper link for 96.02 socket	094.06 (blue)	094.06.0 (black)
Rated values	10 A - 250 V	

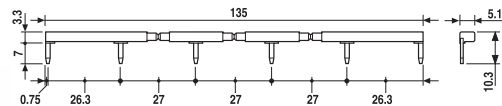

86.00

86 series timer modules	
Multi-voltage: (12...240)V AC/DC;	
Multi-functions: AI, DI, SW, BE, CE, DE, EE, FE; (0.05 s... 100 h)	86.00.0.240.0000
(12...24)V AC/DC; Bi-function: AI, DI; (0.05 s... 100 h)	86.30.0.024.0000
(110...125)V AC; Bi-function: AI, DI; (0.05s...100h)	86.30.8.120.0000
(230...240)V AC; Bi-function: AI, DI; (0.05 s... 100 h)	86.30.8.240.0000



86.30

Approvals (according to type):



99.02

Approvals
(according to type):



DC Modules with non-standard polarity (+A2) on request.

99.02 coil indication and EMC suppression modules for 96.02 and 96.04 sockets		
Diode (+A1, standard polarity)	(6...220)V DC	99.02.3.000.00
LED	(6...24)V DC/AC	99.02.0.024.59
LED	(28...60)V DC/AC	99.02.0.060.59
LED	(110...240)V DC/AC	99.02.0.230.59
LED + Diode (+A1, standard polarity)	(6...24)V DC	99.02.9.024.99
LED + Diode (+A1, standard polarity)	(28...60)V DC	99.02.9.060.99
LED + Diode (+A1, standard polarity)	(110...220)V DC	99.02.9.220.99
LED + Varistor	(6...24)V DC/AC	99.02.0.024.98
LED + Varistor	(28...60)V DC/AC	99.02.0.060.98
LED + Varistor	(110...240)V DC/AC	99.02.0.230.98
RC circuit	(6...24)V DC/AC	99.02.0.024.09
RC circuit	(28...60)V DC/AC	99.02.0.060.09
RC circuit	(110...240)V DC/AC	99.02.0.230.09
Residual current by-pass	(110...240)V AC	99.02.8.230.07

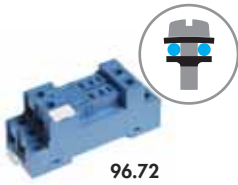

96.72

Approvals
(according to type):

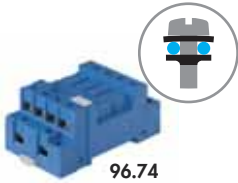

96.74

Approvals
(according to type):



99.01

Approvals
(according to type):



* Modules in Black housing are available on request.

Green LED is standard. Red LED available on request.

Screw terminal (Plate clamp) socket	96.72	96.72.0	96.74	96.74.0
panel or 35 mm rail (EN 60715) mount	Blue	Black	Blue	Black
For relay type	56.32		56.34	
Accessories				
Metal retaining clip (supplied with socket - packaging code SMA)	094.71		096.71	
Modules (see table below)			99.01	
Technical data				
Rated values	12 A - 250 V			
Dielectric strength	2 kV AC			
Protection category	IP 20			
Ambient temperature	°C -40...+70			
⊕ Screw torque	Nm 0.8			
Wire strip length	mm 10			
Max. wire size for 96.72 and 96.74 sockets	solid wire		stranded wire	
	mm ²	1x4 / 2x4	1x4 / 2x2.5	
	AWG	1x12 / 2x12	1x12 / 2x14	

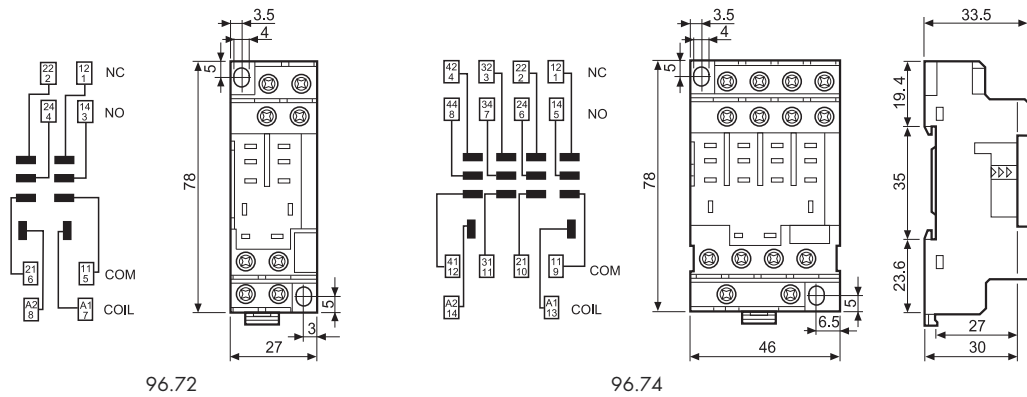

99.01 coil indication and EMC suppression modules for types 96.72 and 96.74 sockets		Blue*
Diode (+A1, standard polarity)	(6...220)V DC	99.01.3.000.00
Diode (+A2, non-standard polarity)	(6...220)V DC	99.01.2.000.00
LED	(6...24)V DC/AC	99.01.0.024.59
LED	(28...60)V DC/AC	99.01.0.060.59
LED	(110...240)V DC/AC	99.01.0.230.59
LED + Diode (+A1, standard polarity)	(6...24)V DC	99.01.9.024.99
LED + Diode (+A1, standard polarity)	(28...60)V DC	99.01.9.060.99
LED + Diode (+A1, standard polarity)	(110...220)V DC	99.01.9.220.99
LED + Diode (+A2, non-standard polarity)	(6...24)V DC	99.01.9.024.79
LED + Diode (+A2, non-standard polarity)	(28...60)V DC	99.01.9.060.79
LED + Diode (+A2, non-standard polarity)	(110...220)V DC	99.01.9.220.79
LED + Varistor	(6...24)V DC/AC	99.01.0.024.98
LED + Varistor	(28...60)V DC/AC	99.01.0.060.98
LED + Varistor	(110...240)V DC/AC	99.01.0.230.98
RC circuit	(6...24)V DC/AC	99.01.0.024.09
RC circuit	(28...60)V DC/AC	99.01.0.060.09
RC circuit	(110...240)V DC/AC	99.01.0.230.09
Residual current by-pass	(110...240)V AC	99.01.8.230.07



96.12

Approvals
(according to type):



PCB socket	96.12 (blue)	96.12.0 (black)	96.14 (blue)	96.14.0 (black)
For relay type	56.32		56.34	
Accessories				
Metal retaining clip (supplied with socket - packaging code SMA)				094.51
Technical data				
Rated values	15 A - 250 V			
Dielectric strength	2 kV AC			
Protection category	IP 20			
Ambient temperature	°C -40...+70			

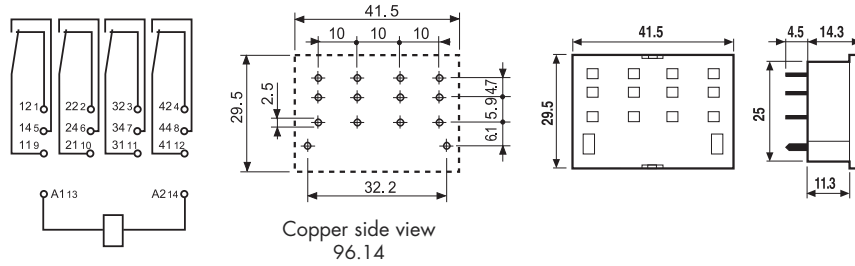
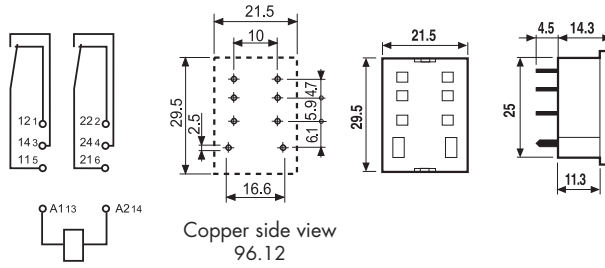

Packaging code

How to code and identify retaining clip and packaging options for sockets.

Example:

9 6 . 7 4 S M A

A Standard packaging

SM Metal retaining clip
SP Plastic retaining clip

9 6 . 7 4 [] []

Without retaining clip

